

SERVICE MANUAL

STEREO 3-HEAD CASSETTE DECK

SANSUI D-970



• SPECIFICATIONS

Track	4-Track (2-Channel Stereo)
Tape speed	4.8 cm/sec. (1-7/8 ips)
Heads	Record/Playback: Ferrite Combination Head Erase: Double Gap Ferrite Head
Motor	Capstan: FG Servo Motor Reels: DC Motor
Wow and flutter	within 0.025 % WRMS
Fast wind time	approximately 80 seconds (C-60)
Frequency response (Record/Playback)	
Normal Tape (LH) (-20 VU)	
.....	20 to 19,000 Hz (30 to 18,000 Hz ± 3 dB)
Metal Tape (-20 VU)	
.....	20 to 23,000 Hz (30 to 22,000 Hz ± 3 dB)
(0 VU)	30 to 13,000 Hz ± 3 dB
Signal to noise ratio (Record/Playback)	
Metal Tape (without Dolby Noise Reduction Effect)	
.....	better than 61 dB (weighted)
(With Dolby Noise Reduction)	
B-NR	better than 71 dB (above 5 kHz)
C-NR	better than 81 dB (above 1 kHz)
Erasure factor (Metal Tape)	
.....	more than 65 dB at 1,000 Hz
Input sensitivity and impedance (0 VU, 1,000 Hz)	
MIC	0.4 mV/200 Ω ~ 5 k Ω
LINE EN (REC)	70 mV/47 k Ω
Output level (0 VU, 1,000 Hz)	
LINE OUT (PLAY)	350 mV
PHONES	200 mV
Power requirements	
Power voltage	100, 120, 220, 240 V (50/60 Hz)
For U.S.A. and Canada	
.....	120 V (60 Hz)
Power consumption	
.....	40 W
Dimensions	430 mm (16-15/16") W 111 mm (4-3/8") H 324 mm (12-3/4") D
Weight	7.1 kg (15.7 lbs) net 8.2 kg (18.1 lbs) packed

* Design and specifications subject to changes without notice for improvements.

* Noise reduction system manufactured under license from Dolby Laboratories Licensing Corporation. "Dolby" and the double D symbol are trade marks of Dolby Laboratories Licensing Corporation.

Sansui

SANSUI ELECTRIC CO., LTD.

1. BLOCK DIAGRAM

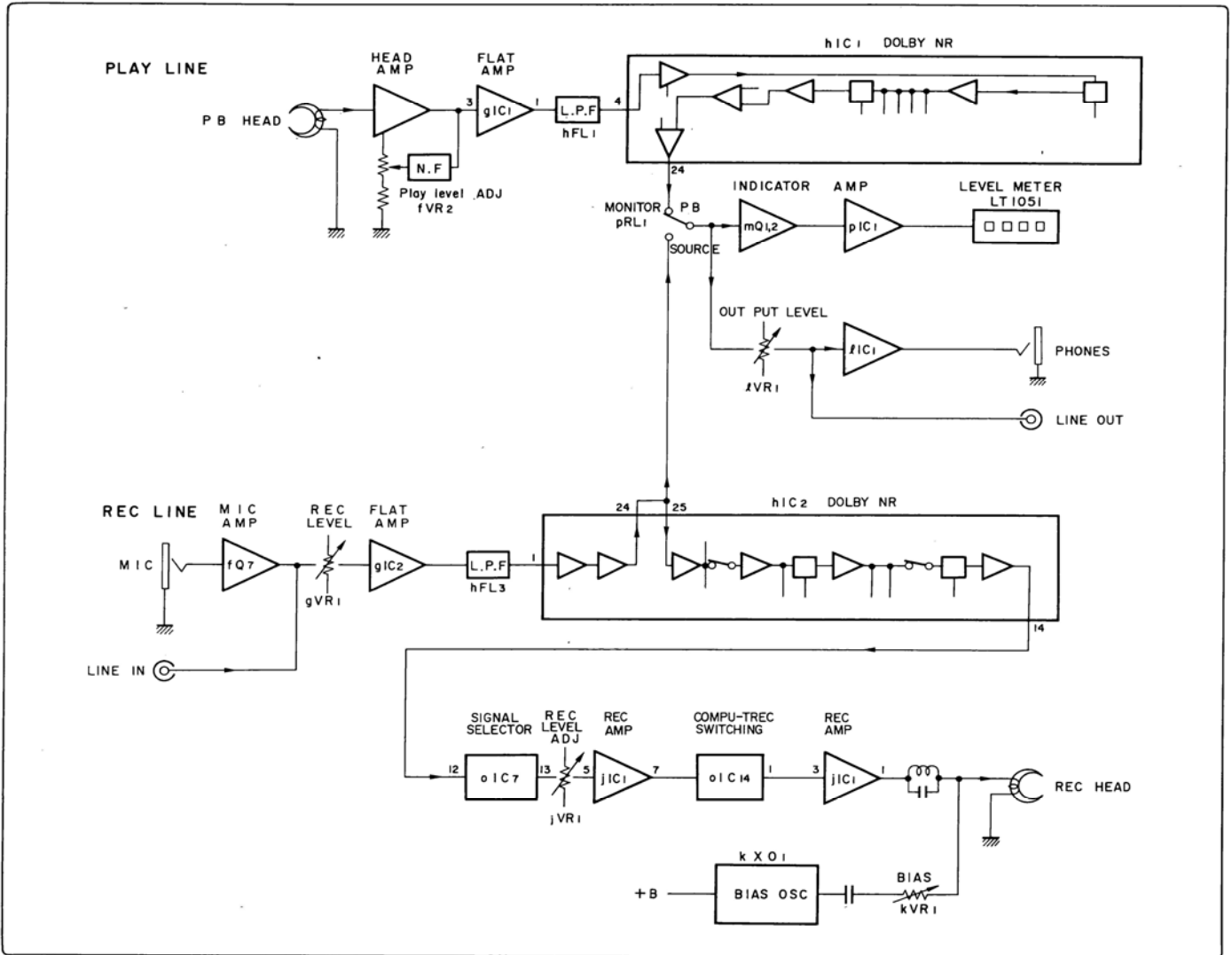

2. OPERATION OF COMPU-TREC (COMPUterized-Tape REsponse Control)

Fig. 2-1 oIC3b comparator input terminal level

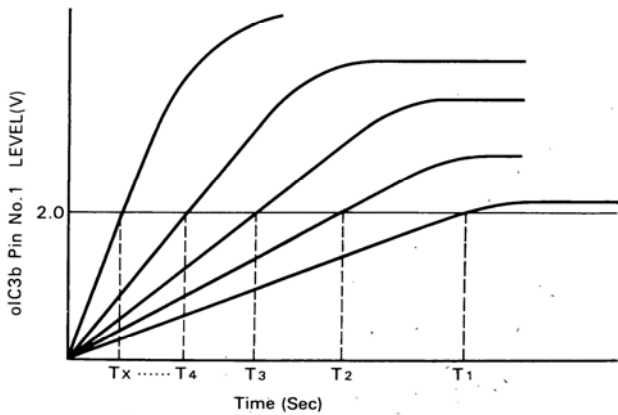

- Since the mechanism operations and electrical operations employed in D-970 are similar to those of D-570, back tension servo operation is similar to that of D-550M, the explanations of these operations are omitted from this manual.

Fig. 2-2

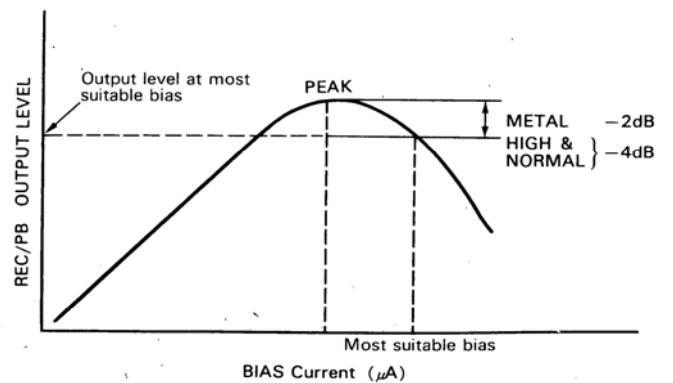
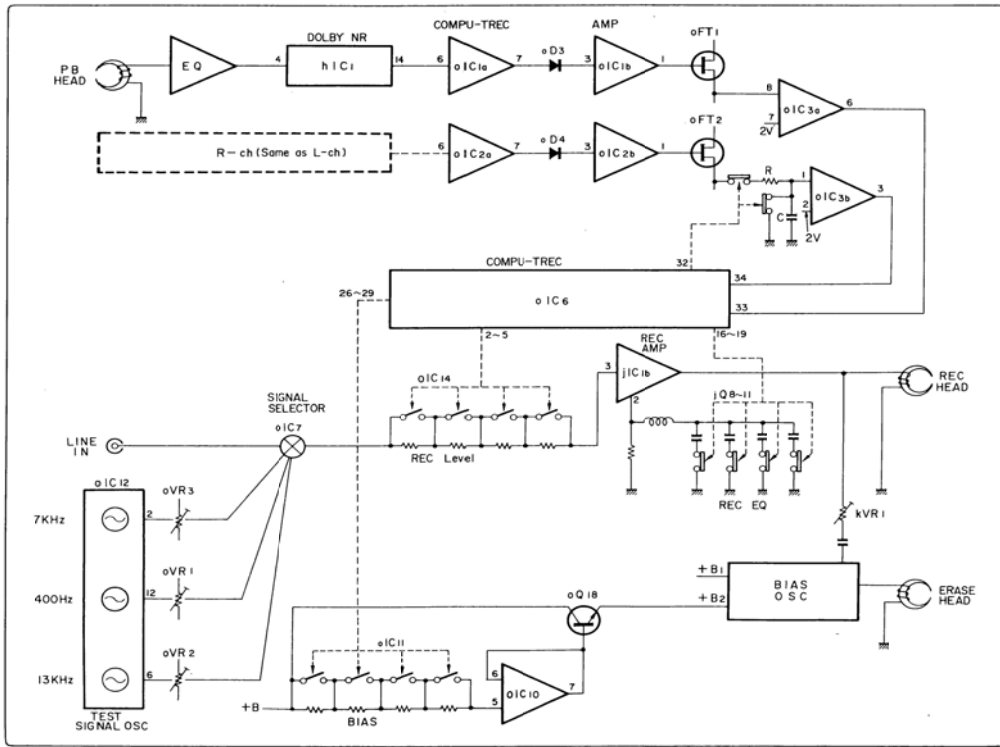

Fig. 2-3 Block diagram of COMPU-TREC



COMPU-TREC system can be conformity with individual factors (bias current, rec level and rec equalizer) of each cassette tape for the purpose of exhibiting most suitable characteristics automatically and speedily. Therefore, it corrects uneven frequency response and error of rec level, it supports stable operation of dolby noise reduction and so on.

2-1. Operation of Bias Current Control

- 1) When the START button is pushed after pushing CLEAR button, and the COMPU-TREC operation starts. On and after step 2) are all automatic operation.
- 2) Test signal is changed from 400 Hz to 7 kHz signal, and REC & PLAY BACK operation start.
- 3) At the same time, bias current is changed from minimum to maximum by resistor (oR66 ~ 69) step by step (16 steps).
- 4) On each step, 7 kHz signal is record, and play back signal is detected by R-ch, it is inputted to the comparator (oIC3b) through the diode (oD4) and integral circuit.
- 5) The voltage of pin 2 (oIC3b) is 2 V constant.
- 6) Therefore, it takes (T) seconds to rise the voltage of pin 1 (oIC3b) up to 2 V, and to apply output (oIC3b) signal. (See Fig. 2-1)
- 7) Since the bias current level influences to the record/playback level, the rise time (T) is also changed. (See Figs. 2-1, 2-2)
- 8) At maximum record/playback level, then the rise time is minimum.

- 9) oIC6 (μ PD546C) memorize the relation of rise time and bias current on each step, since it control over bias level to apply maximum record/playback level, level of realizing the rise time that and (Tbest) time equal.

2-2. Operation of Rec Level Control

Rec Level adjustment starts after "2-1. Bias current control" automatically.

- 1) Test signal is changed from 7 kHz to 400 Hz signal.
- 2) Record and play back level is changed from minimum to maximum by resistor (jR9 ~ 12) step by step (16 steps).
- 3) On each step, 400 Hz signal is record, and play back signal are inputted to pin 8 (oIC3a) and pin 1 (oIC3b) through diode (oD3, oD4) and integral circuit.
- 4) The voltage of pin 8 and 1 (oIC3) rise up to 2 V, then oIC6 memorize the rec level as most suitable level.

2-3. Operation of Rec Equalizer Control

Rec equalizer adjustment starts after "2-2. Rec level control" automatically.

- 1) Test signal is changed from 400 Hz to 13 kHz signal.
- 2) Rec equalizer changed 16 steps by capacitor (jC14 ~ 17) of rec amplifier. (See Fig. 2-5)
- 3) On each steps, 13 kHz signal is record, and play back signal are inputted to pin 8 and 1 (oIC3) through diode (oD3, 4) and integral circuit.
- 4) The voltage of pin 8 and 1 (oIC3) rise up to 2 V, then oIC6 memorize the rec equalizer as most suitable equalizer.

Fig. 2-4 Flow chart of COMPU-TREC operation



Fig. 2-5

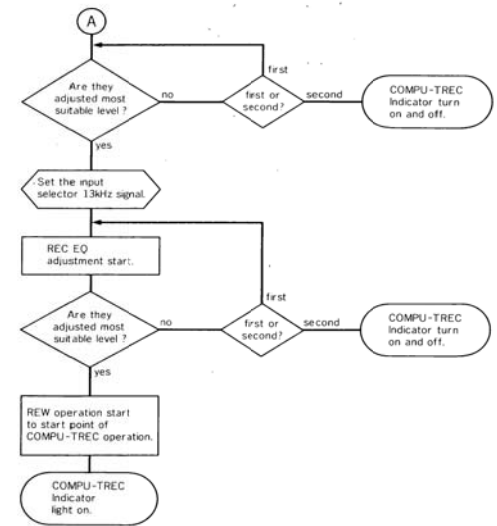
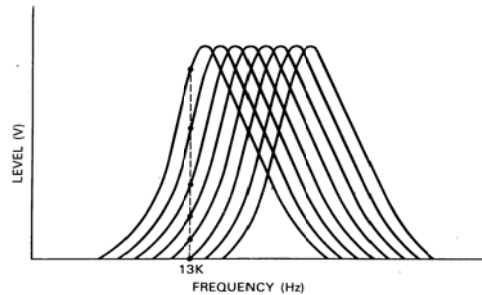
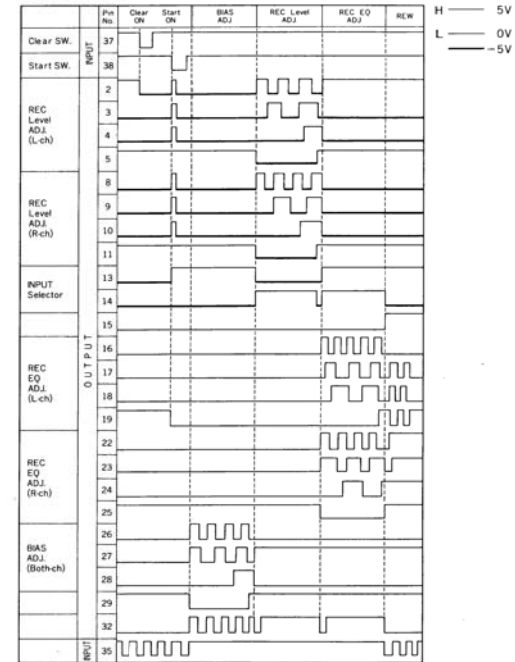

Fig. 2-6 COMPU-TREC IC < μ PD-546C> timing chart



3. ADJUSTMENTS

3-1. Tape Speed Adjustment

- Note: 1. Use Sansui Test Tape, SCT-S3K (3 kHz signal are recorded on the tape).
2. Connections are shown in Fig. 3-1.

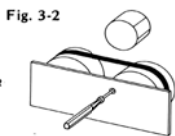
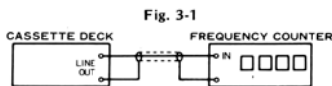

STEP	SUBJECT	MEASURE OUTPUT	SETTING	ADJUSTMENT	ADJUST FOR	REMARKS
1.	TAPE SPEED Adj.	LINE OUT Frequency	Playback the TEST TAPE SCT-S3K.	Turn semi-variable resistor as Fig. 3-2.	3000Hz ± 45Hz	Use small screw driver.

3-2. Equalizer Adjustment (See Fig. 3-3)

- Note: 1. Master Volume Minimum
2. Room Temperature 18°C ~ 28°C (65°F ~ 83°F)
3. Before turning ON POWER switch, set fVR1-L, fVR1-R to center position.
4. For this adjustment, run the unit for more than 3 minutes after the power is switched ON.

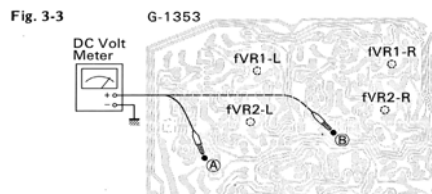

STEP	SUBJECT	MEASURE OUTPUT	ADJUST	ADJUST FOR	REMARKS
1.	DC 0V Adj. L-ch	Between GND & Point (A)	fVR1-L G-1353	DC 0V ± 100mV	
2.	DC 0V Adj. R-ch	Between GND & Point (B)	fVR1-R G-1353		

3-3. Playback Adjustment

- Note: 1. Before this adjustment, clean REC/P.B. head surface.
2. Output Volume MAX.
3. For this adjustment, use Sansui Test Tape, SCT-F10KN, SCT-L400N and SCT-F1K.
4. Set the Dolby NR switch to be OFF.
5. MONITOR SWITCH TAPE
6. Connections are shown in Fig. 3-4.

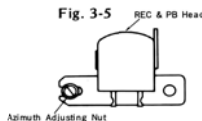
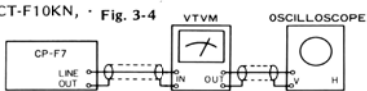

STEP	SUBJECT	MEASURE OUTPUT	SETTING	ADJUSTMENT	ADJUST FOR	REMARKS
1.	REC/P.B. Head Adj.	LINE OUT VTVM, Scope	Playback the TEST TAPE SCT-F10KN	Adjust the azimuth adjusting Nut Fig. 3-5.	MAX. Output on both channels.	After this adjustment, lock the Nut with paint.
2.	Playback Level Adj.	Same as above	Set TAPE SELECTOR to NORMAL (LH) position. Playback the TEST TAPE SCT-L400N.	Adjust each fVR2 on L-CH and R-CH.	540mV ± 2dB	See Fig. 3-3.
3.	High Frequency Equalization Check	Same as above	Set TAPE SELECTOR to NORMAL (LH) position. Playback the TEST TAPE SCT-F1K.	—	—	Read output levels on both channels.
			Playback the TEST TAPE SCT-F10KN.	—	—	Confirm that the output levels are within ± 3dB comparing with the above readings.

Note: On STEP 3, set the TAPE SELECTOR to HIGH (CrO₂) position during playback of SCT-10k, and confirm the indication on VTVM drops approximately 3dB ~ 4dB.

3-4. Recording Adjustment

1) Bias Frequency Adjustment

- * Perform this adjustment when bias pot or REC/PB head replaced.
Note: 1. For this adjustment, use Sansui Test Tape, SCT-MA.
2. Set the Dolby NR Switch to be OFF.
3. Connections are shown in Fig. 3-6.

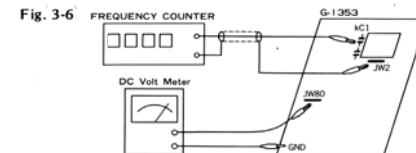

STEP	SUBJECT	MEASURE OUTPUT	SETTING	ADJUSTMENT	ADJUST FOR	REMARKS
1.	Bias Frequency Adj.	Between capacitor(kC1) & jamper wire (jW2) Frequency counter	Load TEST TAPE SCT-MA Push on REC & PLAY buttons. Set TAPE SELECTOR to METAL (MA) Position.	Adjust Black core of OSC block (kXO1)	105 kHz ± 5 kHz	Black and Red cores are shown in Top View on page 19.
	DC Volt of Bias OSC Block Adj.	Between jumper wire (JW80) & GND. DC Volt Meter	Same as above	Adjust Red core of OSC block (kXO1)	Max. Output	

2) REC Level & Frequency Response Adjustment

- Note: 1. For this adjustment, use Sansui Test Tape SCT-SA.
2. Output Volume MAX.
3. Connections are shown in Fig. 3-7.
4. MONITOR SWITCH SOURCE
5. Set the Dolby NR switch to be OFF.

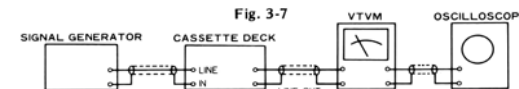

STEP	SUBJECT	INPUT SIGNAL	MEASURE OUTPUT	SETTING	ADJUSTMENT	REMARKS
1.	REC Level Adj.	Feed 1kHz, 100mV from S.G into LINE IN	LINE OUT VTVM Scope	Load the TEST TAPE SCT-SA. Set TAPE SELECTOR to HIGH (CrO ₂) position. 1. Push on PLAY and REC button 2. Adjust the Rec Level Volume for obtaining 380mV on VTVM. 3. Push off the MONITOR switch to be TAPE, then record and playback the 1kHz signal. 4. Confirm that the output levels on both channels are 380mV ± 2dB on VTVM.	1. If not, turn jVR1 (REC, L-CH) and jVR1 (REC, R-CH) until output level 380mV ± 2dB on both channel are obtained. 2. Repeat this REC Level adj. until the indication on VTVM will be 380mV ± 2dB.	jVR1 (REC, L-CH), and jVR1 (REC, R-CH) are shown in Top View on page 19.
2.	Frequency Response Adj.	Feed 1kHz 7mV (-20dB) and 13kHz 7mV (-20dB) from S.G. into LINE IN.	Same as above	Load the TEST TAPE SCT-SA. Set TAPE SELECTOR to HIGH (CrO ₂) position. 1. REC LEVEL Volume . . . Max. 2. Record the 1kHz and 13kHz signals from S.G. 3. Playback the 1kHz and 13kHz signals, then confirm 13kHz signal level in less than 1kHz signal level ± 3dB on VTVM.	1. If not, adjust kVR1L for L-CH and kVR1R for R-CH slightly.	After this adjustment, perform the SETTING 2 ~ 3 again.
3.	Playback side bias trap Adj.	—	Same as above	Load the TEST TAPE SCT-SA. Set TAPE SELECTOR to METAL position. 1. Push of the MONITOR switch to be TAPE. 2. Set the Rec Level Volume to be minimum.	Adjust each hFL1 on L-CH and R-CH, until the Bias signal will be minimum on Scope and VTVM.	hFL1 (PB, L-ch) and hFL1 (PB; R-ch) are shown in Top View on page 19.

3-5. COMPU-TREC Adjustment

- Note:** 1. For this adjustment, use Sansui Test Tape SCT-SA.
 2. Output Volume . . . MAX.
 3. Connections are shown in Fig. 3-8.
 4. TAPE SELECTOR . . High (CrO₂)
 5. MONITOR SWITCH . SOURCE
 6. Set the Dolby NR switch to be OFF.
 7. After push on the CLEAR button, and the START button.

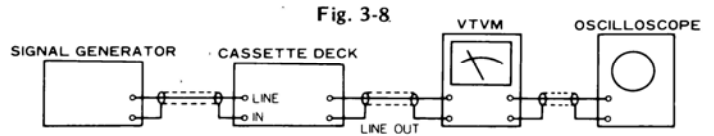

STEP	SUBJECT	INPUT SIGNAL	MEASURE OUTPUT	SETTING	ADJUSTMENT	REMARKS
1.	COMPU-TREC Bias Adj.		Between center Pin of oVR3 or Pin 5 of IC7 & GND. VTVM, Scope	1. Load the TEST TAPE SCT-SA 2. After one second, the signal level go up more. 3. Then confirm the level is 105 mV on VTVM.	1. If not, adjust oVR3 until the signal level 105 mV is obtained.	The signal is generated about two seconds. If signal level is not obtained 105 mV. Push on the CLEAR, and the START button again, perform the "ADJUSTMENT 1", again.
2.	COMPU-TREC REC Level Adj.	SCT-SA Feed 1kHz, 100mV from S.G into LINE IN	LINE OUT VTVM, Scope	Load the TEST TAPE SCT-SA. 1. Push on PLAY and REC button. 2. Adjust the Rec Level Volume for obtaining 380mV on VTVM. 3. Push off the MONITOR switch to be TAPE, then record and Play back the 1kHz signal. 4. Confirm that the output levels on both channels are 380mV on VTVM.	1. If not, adjust oVR1 slightly. 2. Push on the CLEAR, and START button. 3. Repeat this REC Level adj. until the indication on VTVM will be 380mV.	oVR1 is shown in Top View on page 19. * If more than it, refer to Fig. 3-9 (A). If less than it, refer to Fig. 3-9 (B).
3.	COMPU-TREC REC EQ Adj.	Feed 1kHz 7mV (-20dB) and 13kHz (-20dB) from S.G. into LINE IN.	Same as above	Load the TEST TAPE SCT-SA. 1. Record and Play back the 1kHz and 13kHz signals from S.G., then confirm that both output levels equal.	1. If not, adjust oVR2 slightly. 2. Push on the CLEAR, and START button. 3. Repeat this REC EQ adj., until the both output levels will be equal.	oVR2 is shown in Top View on page 19. * If 13kHz output level more than 1kHz output level, refer to Fig. 3-9 (A). If 13kHz output level less than 1kHz output level, refer to Fig. 3-9 (B).

Fig. 3-9 oVR1, oVR2

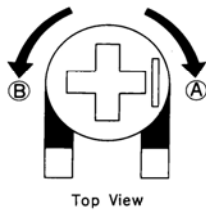

3-6. Peak Level Indicator Adjustment

- Note:** 1. Set the TAPE SELECTOR to be NORMAL (LH) position.
 2. Output Volume . . . MAX.
 3. Set the Dolby NR Switch to be OFF.
 4. MONITOR SWITCH . SOURCE
 5. Connections are shown in Fig. 3-10.

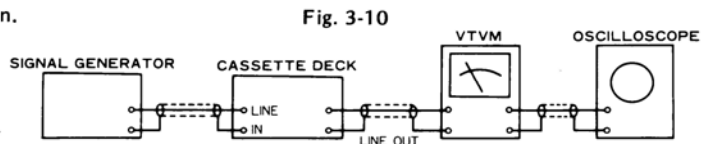

STEP	SUBJECT	INPUT SIGNAL	MEASURE OUTPUT	SETTING	ADJUSTMENT	REMARKS
1.	Peak Level Indicator Adjustment	Feed 1kHz, 140mV from S.G. into LINE IN	LINE OUT VTVM Scope	Load the TEST TAPE SCT-SA 1. Adjust the REC Level Volume for obtaining 540mV on VTVM.	1. Light the 0dB point on level indicator to adjust mVR1. 2. Adjust the REC LEVEL Volume for obtaining 500mV on VTVM, then confirm the 0dB point on level indicator go out. 3. If not, adjust mVR1, until SETTING 1 ~ ADJUSTMENT 2 will be obtain:	mVR1 are shown in Top View on page 19.

3-7. Back Tension Servo Adjustment (See Fig. 3-11)

Note: 1. Use Torque meter for Back Tension.

STEP	SUBJECT	MEASURE OUTPUT	SETTING	ADJUSTMENT	ADJUST FOR
1.	Back Tension Servo Adj.		1. Remove Bonnet, Front panel and mechanism cover. 2. Put a paper between the points of half switch (as ₂) 3. Push on PLAY Button.	Adjust the adjusting plate (A).	It is to adjust the tip of Back Tension Servo arm so as to 0.3mm to 0.8mm upward from the center of active scrape filter.
		Torque meter	1. Take off a paper at the points of half switch (as ₂). 2. Load the torque meter. 3. Push on PLAY Button.	Adjust the adjusting plate (B) in Fig. 3-7 until the Back Tension on torque meter will be 3g-cm to 5g-cm.	

Fig. 3-11

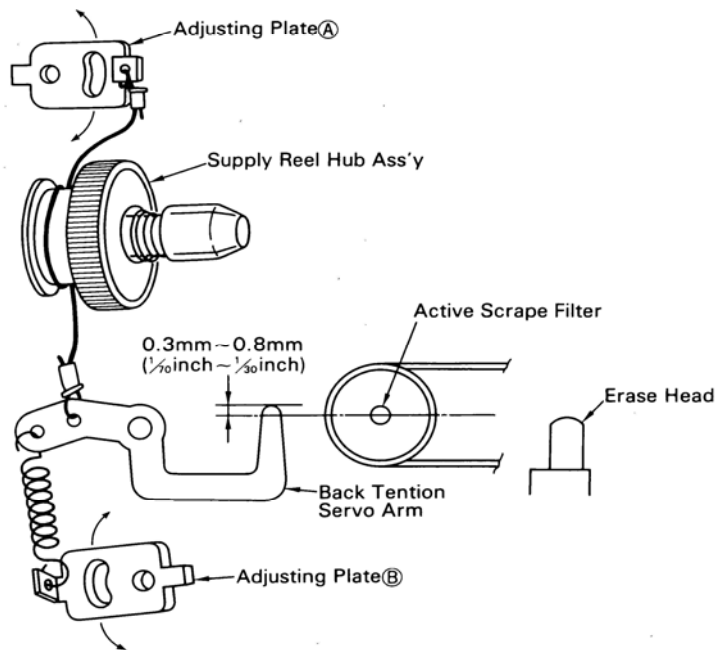

◆ List of Sansui Test Tape

Name of TEST TAPE	Recorded Frequency	Description
SCT-F40	40 Hz	Playback Frequency Response Check
SCT-F1K	1kHz	High Frequency Equalization Check
SCT-F10k	10 kHz	REC/PB Head Adjustment
SCT-L400N	400 Hz	Playback Level and Indicator Level Adjustment
SCT-S3K	3 kHz	Speed Check and Wow & Flutter Check
SCT-LH NORMAL (LH)		Recording Bias Adjustment
SCT-SA HIGH (CrO ₂)		REC/PB Level Adjustment
SCT-MA (METAL)		Frequency Response Check

◆ Tape Selector Position

NORMAL Position		HIGH Position	
FUJI	FL, FXI	FUJI	FX II
MAXELL	UL, UD, XLI	MAXELL	XL II
TDK	D, AD, OD	TDK	SA
SCOTCH	TARTAN CRYSTAL MASTER 120	SCOTCH	MASTER 70
SONY	AHF, BHF, CHF Low-Noise	SONY	JHF
AGFA	SUPER SUPER COLOR SUPER FERRO DYNAMIC	AGFA	STEREO CHROM
BASF	LN Super LH I	BASF	SCR
METAL Position			
		MAXELL	MX
		TDK	MA-R, MA
		SCOTCH	Metafine
		SONY	METALLIC

Parts List <G-1348>

Parts No.	Stock No.	Description
•IC		
jIC1	46147700	M5218L
oIC1, 2	46147700	M5218L
oIC3	46160600	M51207L
oIC4	07264600	MSM4066RS
oIC5	03609500	MSM4001RS
oIC6	46208600	μPD546C-312
oIC7	03609700	MSM4052RS
oIC8	46220500	M53203P
oIC9	46209500	MSM4019RS
oIC10	46147700	M5218L
oIC11	07264600	MSM4066RS
oIC12	03605700	MSM4069RS
oIC13	46220600	M53207P
oIC14, 15	07264600	MSM4066RS
•Diode		
jD1, 2	03117600 or 46086000 or 46092700	1S2473D 1S1588 US1035
oD1~9	03117600 or 46086000 or 46092700	1S2473D 1S1588 US1035
oD18~21	03117600 or 46086000 or 46092700	1S2473D 1S1588 US1035
•FET		
oFT1, 2	03703000, 1	2SK117-O, Y
gVR1	46177000	50kΩ (A) VR, REC LEVEL
jVR1	10370800	20kΩ (B) SVR, rec level ADJ.
kVR1	10371000	100kΩ (B) SVR, bias ADJ.

Parts No.	Stock No.	Description
oVR1, 2	10370700	10kΩ (B) SVR, compu-trec (400, 13 kHz)
oVR3	10370400	1kΩ (B) SVR, compu-trec (7 kHz)
jTH1	46257300	Thermistor
jFL1	46220400	Trap Coil (105 kHz)
jL2	46090900	Inductor (5.6 mH)
kXO1	46208900	OSC Block, bias
oXO1	09300700	OSC Block, logic
•Resistor		
oR37	46037800	2.7k (Array-4)
oR38, 63	46038900	22k (Array-4)
oR64	46037800	2.7k (Array-4)
oR65, 75	46038900	22k (Array-4)
oR76	46038900	22k (Array-4)
pR20	0C184900	82Ω 1W N.I.R.
pR22	00179100	100Ω 1W N.I.R.
•Capacitor		
oC3, 4	07216800	0.068μF 25V C.C.
oC6~9	07216400	0.033μF 25V C.C.
oC20	07216200	0.022μF 25V C.C.
oC24	07215300	0.0039μF 25V C.C.
oC27, 30	07216800	0.068μF 25V C.C.
oC32	07216800	0.068μF 25V C.C.
oC29, 31	07215000	0.0022μF 25V C.C.
oC33	07215000	0.0022μF 25V C.C.
oC39	07215800	0.01μF 25V C.C.
oPL1	46220700	Pilot Lamp, 8V 50mA
pS2	46178000	Push SW., TAPE SELECTOR

4-2. G-1350 Headphone Amp. Circuit Board (Stock No. 00684001)

Component Side

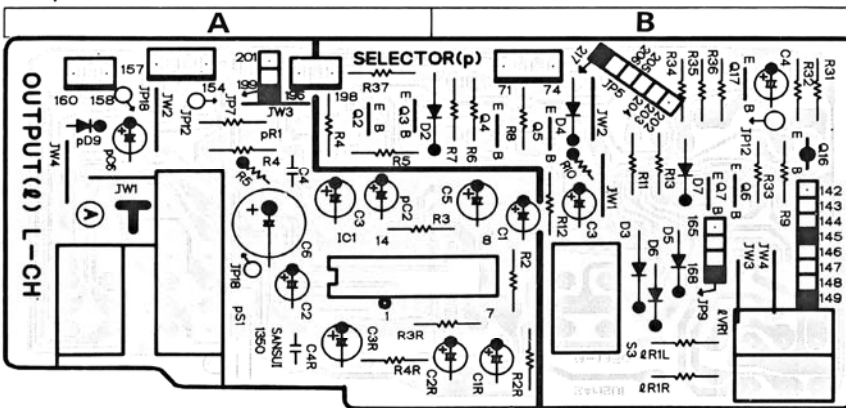

Parts List

Parts No.	Stock No.	Description
•IC		
IC1	07224500	LA4170
IVR1	46208800	10kΩ (B) VR, OUTPUT
•Transistor		
pQ2~7	03068301 or 07299701 or 07194801	2SC2320 2SC2603 2SC1815
pQ16	03012701 or 07299601 or 07194701	2SA999 2SA1115 2SA1015

Parts No.	Stock No.	Description
pQ17	03068301 or 07299701 or 07194801	2SC2320 2SC2603 2SC1815
•Diode		
pD2, 3	03117700	10E-2
pD4~7	03117600 or 46086000 or 46092700	1S2473D 1S1588 US1035
pS1	46177900	Push SW., DOLBY
pS3	46221300	Push SW., TAPE MONITOR

4-3. G-1341 Mechanism Control & Power Supply Circuit Board (Stock No. 00683101)

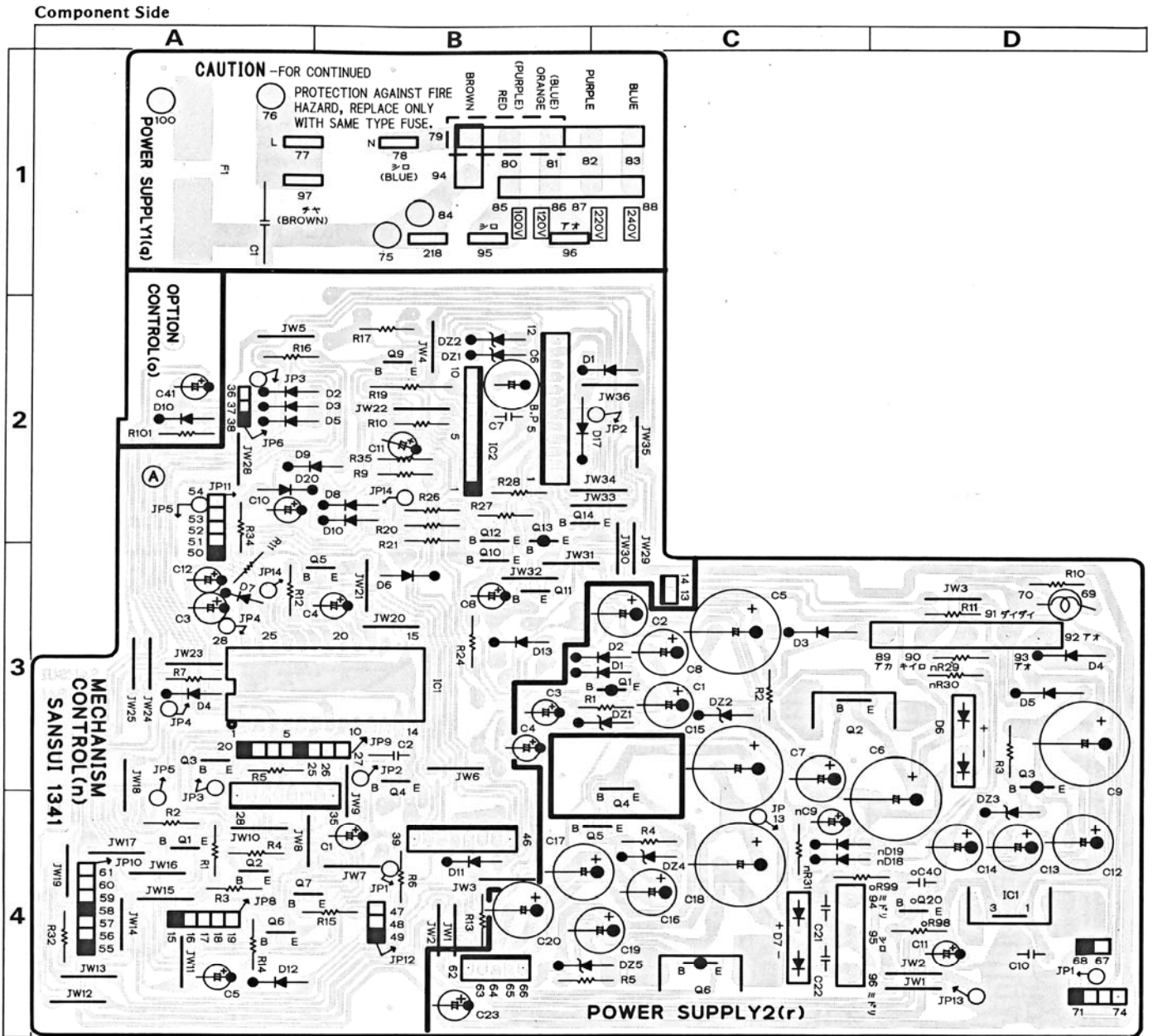

Parts List

Parts No.	Stock No.	Description
●Transistor		
nQ1~10	03068301	2SC2320
	or 07299701	2SC2603
	or 07194801	2SC1815
nQ11	46134200	2SD1111
nQ12	03068301	2SC2320
	or 07299701	2SC2603
	or 07194801	2SC1815
nQ13	07206801	2SA952
nQ14	46134200	2SD1111
oQ20	03068301	2SC2320
	or 07299701	2SC2603
	or 07194801	2SC1815
rQ1	03012701	2SA999
	or 07299601	2SA1115
	or 07194701	2SA1015
rQ2	03084501	2SD356
	or 03086101	2SD357
	or 03084801	2SD358

Parts No.	Stock No.	Description
rQ3	07263401	2SB631
	or 07206301	2SB631K
rQ4	03084501	2SD356
	or 03086101	2SD357
	or 03084801	2SD358
rQ5	03068301	2SC2320
	or 07299701	2SC2603
	or 07194801	2SC1815
rQ6	03032801	2SB526
	or 03034401	2SB527
	or 03033101	2SB528
●IC		
nIC1	46178200	MSM5836RS
nIC2	07233100	BA6109
rIC1	07183500	μPC78M05H

to be continued ▶

Parts List <G-1341>

Parts No.	Stock No.	Description	Parts No.	Stock No.	Description
●Diode			rDZ1	46115400	05Z20Y
nD1~16	03117600	1S2473D	rDZ2	46113800	05Z12X
	or 46086000	1S1588	rDZ3	46111500	05Z5.6Y
	or 46092700	US1035	rDZ4	46114300	05Z13Z
nD17	03117700	10E-2	rDZ5	46114100	05Z13X
nD18, 19	03117600	1S2473D			
	or 46086000	1S1588	nR19	00182100	33Ω 1W N.I.R.
	or 46092700	US1035	●Capacitor		
nD20	03111600	1S2473D	nC6	08460800	100μF 10V B.P.
			oC40	07215800	0.01μF 25V C.C.
oD10	03117600	1S2473D	qC1	08302200	0.01μF 125V C.C.
	or 46086000	1S1588	or 08302600		0.01μF 400V C.C.
	or 46092700	US1035	rC21, 22	00406200	0.01μF 100V F.C.
rD1~5	03117700	10E-2	nPL1	46177100	Pilot Lamp, 12V 0.1A
rD6, 7	03117000	RB-152		51863610	Earth Washer
●Zener Diode					
nDZ1	46112000	05Z6.8X			
nDZ2	46111200	05Z5.1Y			

4-4. G-1353 Noise Reduction & Head Amp. Circuit Board (Stock No. 00684301)

Component Side

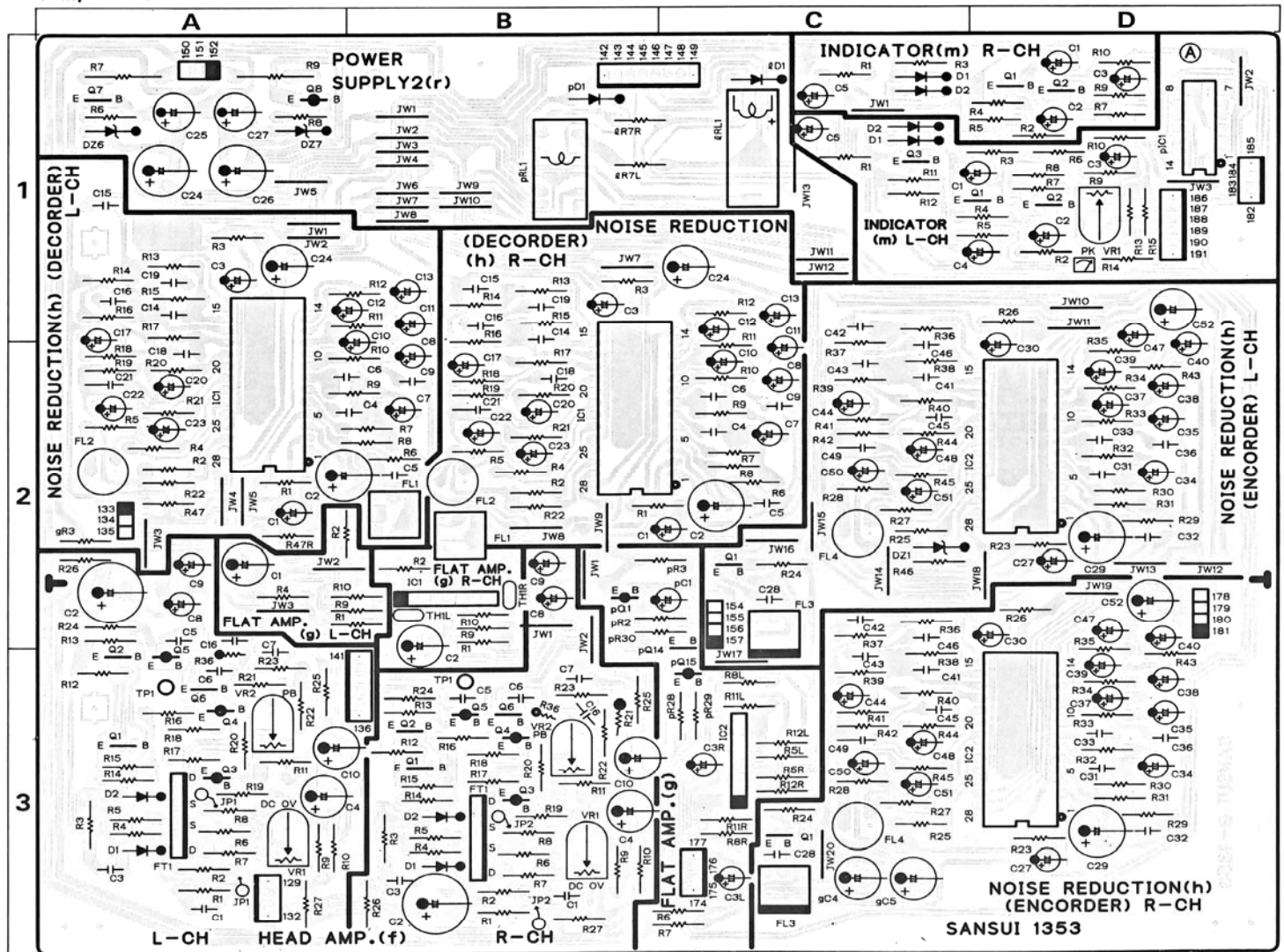

Parts List

Parts No.	Stock No.	Description
●Transistor		
fQ1, 2	03067401	2SC1845
	or 07299101	2SC2240
fQ3~5	03010901	2SA992
	or 07299001	2SA970
fQ6	03067401	2SC1845
	or 07299101	2SC2240
hQ1	03068301	2SC2320
	or 07299701	2SC2603
	or 07194801	2SC1815
mQ1~3	03068301	2SC2320
	or 07194801	2SC1815
	or 07299701	2SC2603
pQ1, 15	03012701	2SA999
	or 07299601	2SA1115
	or 07194701	2SA1015
pQ14	03068301	2SC2320
	or 07299701	2SC2603
	or 07194801	2SC1815
rQ7	07263501	2SD600
	or 07206401	2SB600K
rQ8	07263401	2SB631
	or 07206301	2SB631K
●FET		
fFT1	07110000, 1	μPA68H-L, M
●Diode		
fd1, 2	03401700	MV103
ID1	03117600	1S2473D
	or 46086000	1S1588
	or 46092700	US1035
mD1, 2	03117600	1S2473D
	or 46086000	1S1588
	or 46092700	US1035
pD1	03117600	1S2473D
	or 46086000	1S1588
	or 46092700	US1035

Parts No.	Stock No.	Description
●IC		
gIC1, 2	46147700	M5218L
hIC1, 2	46255300	HA12038-01
pIC1	07264600	MSM4066RS
●Zener Diode		
hDZ1	46111200	05Z5.1Y
rDZ6, 7	46112400	05Z75Y
●Filter		
hFL1	46179100	Filter, dolby
hFL2, 4	46177600	Filter, 19.8 MHz
hFL3	46179200	Filter, dolby
fC5, 6	46073600	22pF 125V P.C.
hC19, 46	46074200	39pF 125V P.C.
fVR1, 2	46257400	200Ω (B) SVR, DC 0V ADJ., PB Level
mVR1	10370600	5kΩ (B) SVR, peak level adj.
IRL1	46221400	Relay, MUTE
pRL1	11505100	Relay, REC/PLAY
gTH1	46257300	Thermistor
rR7, 9	00180100	15Ω 1W N.I.R.

4-5. G-1343 Option Control Switch Circuit Board (Stock No. 00683301)

Component Side

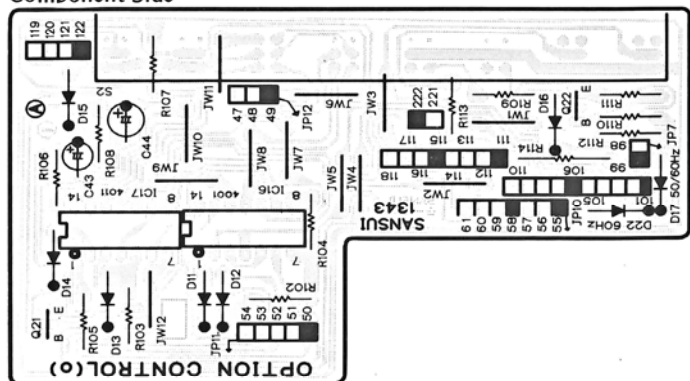

Parts List

Parts No.	Stock No.	Description
●Transistor		
oQ21, 22	03068301	2SC2320
	or 07299701	2SC2603
	or 07194801	2SC1815
●IC		
oIC16	03609500	MSM4001RS
oIC17	03604000	MSM4011RS
●Diode		
oD11~17	03117600	1S2473D
	or 46086000	1S1588
	or 46092700	US1035
oD22	07176400	1S2473HS
oR114	00182200	330Ω 1W N.I.R.
oS2	46208700	Push SW., COUNTER, DUAL MEMORY, AUTO, COMPU-TREC

• Note: The circuit board, G-1342, G-1344, G-1345, G-1346, G-1349, G-1351 & G-1352 are not supplied as the assembled. However, the Individual parts on the circuit board are provided by orders.

4-6. G-1342 Control Switch Circuit Board

Component Side

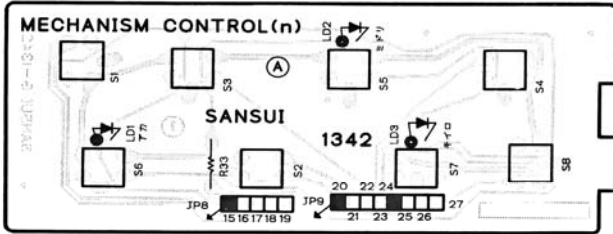

Parts List

Parts No.	Stock No.	Description
nLD1	46176900	TLS123 (RED), REC
nLD2	07250900	TLG123 (GRN), PLAY
nLD3	07251000	TLY123 (YEL), PAUSE
nS1~8	46170500	Push SW., control, REC MUTE, TAPE LEAD IN

4-9. G-1346 Real Time Switch Circuit Board

Parts List

Parts No.	Stock No.	Description
oS1	11102800	Slide SW., REAL TIME SET

4-10. G-1349 Mic. Amp. Circuit Board

Component Side

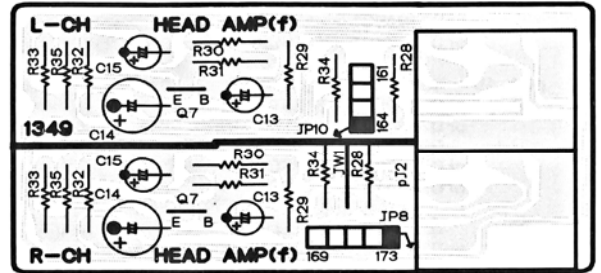

Parts List

Parts No.	Stock No.	Description
fQ7	07225401	2SC2320L
pJ2	46212000	Jack, MIC

4-7. G-1344 Indicator Circuit Board

Parts List

Parts No.	Stock No.	Description
mLD1~5	07250900	TLG124 (GRN)
mPL1, 2	07193600	Lamp, MONITOR

4-11. G-1351 Input/Output Terminal Circuit Board

Parts List

Parts No.	Stock No.	Description
pJ3	07249100	4P INPUT/OUTPUT Terminal Board

4-8. G-1345 Timer Switch Circuit Board

Parts List

Parts No.	Stock No.	Description
nS9	46177800	Slide SW., TIMER

4-12. G-1352 Phone Jack Circuit Board

Parts List

Parts No.	Stock No.	Description
pJ1	46265700	Jack, PHONES

• Abbreviations

C.R. : Carbon Resistor	E.B. : Bi-Polar Electrolytic Capacitor
S.R. : Solid Resistor	E.BL. : Low Leak Bi-Polar Electrolytic Capacitor
Ce.R. : Cement Resistor	Ta.C. : Tantalum Capacitor
M.R. : Metal Film Resistor	F.C. : Film Capacitor
F.R. : Fusing Resistor	M.P. : Metalized Paper Capacitor
N.I.R. : Non-Inflammable Resistor	P.C. : Polystyrene Capacitor
C.C. : Ceramic Capacitor	G.C. : Gimmic Capacitor
C.T. : Ceramic Capacitor, Temperature Compensation	V.R. : Variable Resistor
E.C. : Electrolytic Capacitor	S.V.R. : Semi Variable Resistor
E.L. : Low Leak Electrolytic Capacitor	SW. : Switch

5. SCHEMATIC DIAGRAM S-1. Amplifier Section I

*Design and specifications subject to change without notice for improvement.
 * La présentation et les spécifications sont susceptibles d'être modifiées sans préavis par suites d'améliorations éventuelles.
 * Änderungen, die dem technischen Fortschritt dienen, bleiben vorbehalten.

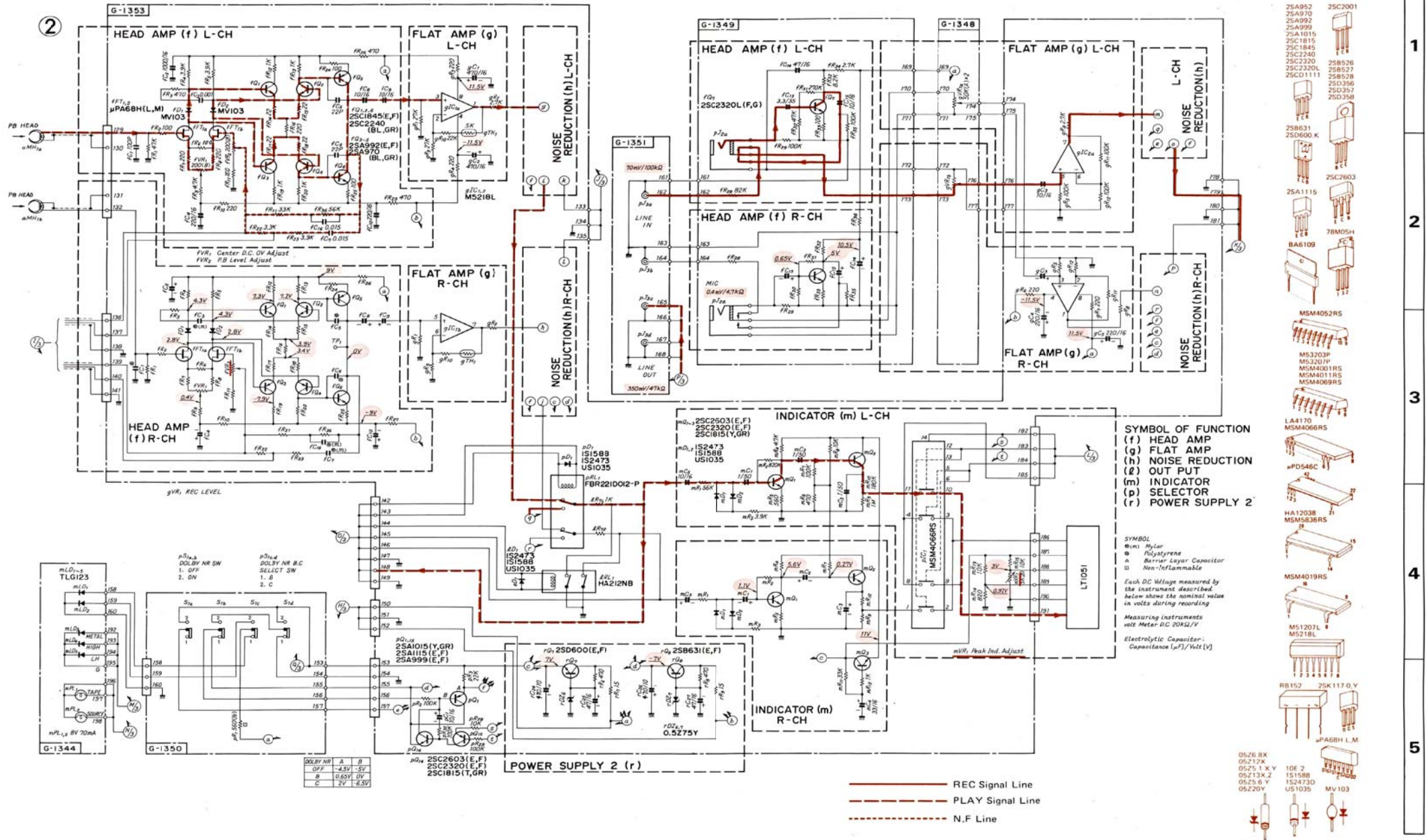

1
2
3
4
5

5-2. Amplifier Section II

* Design and specifications subject to change without notice for improvement.
 * La présentation et les spécifications sont susceptibles d'être modifiées sans préavis par suites d'améliorations éventuelles.
 * Änderungen, die dem technischen Fortschritt dienen, bleiben vorbehalten.

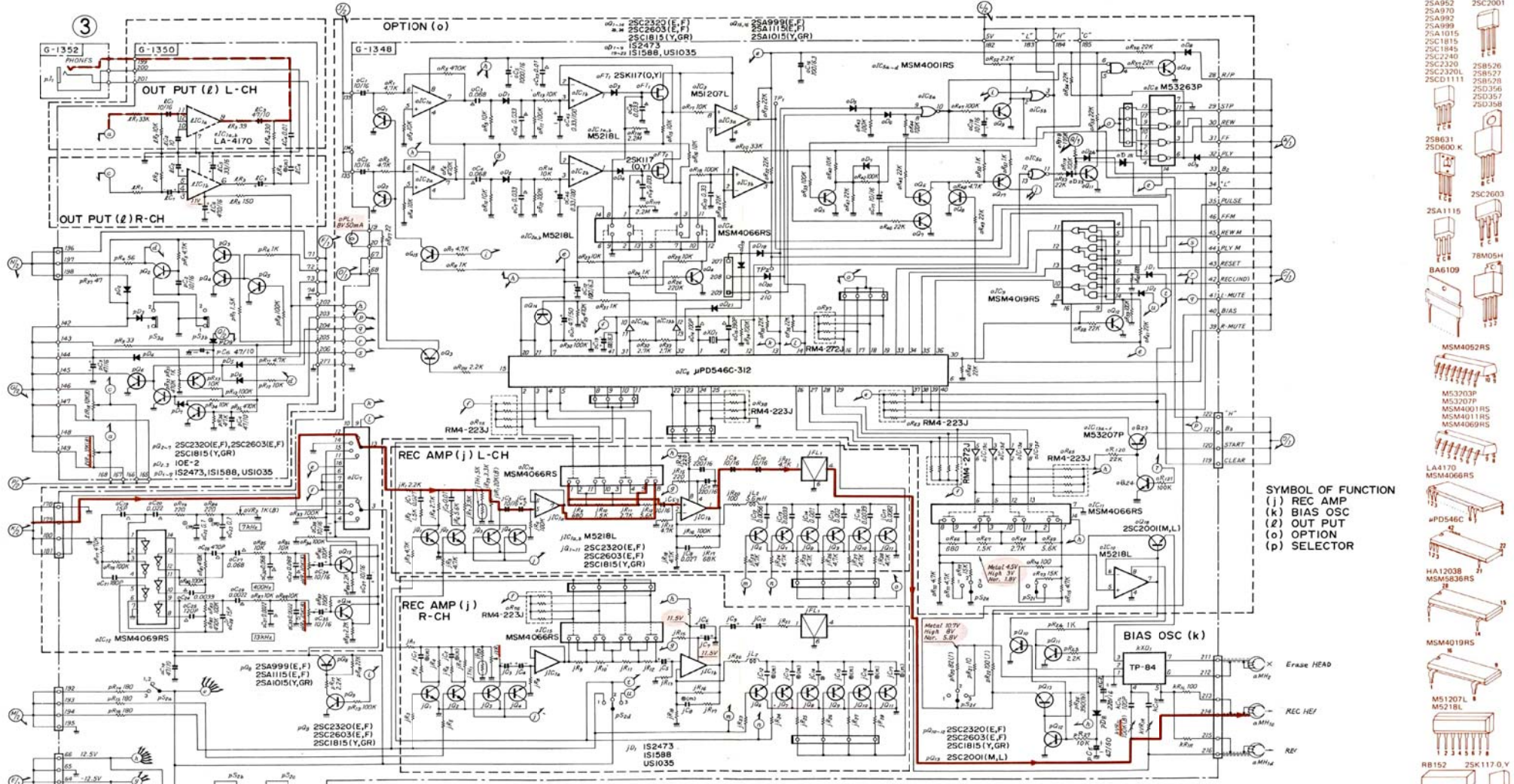

SYMBOL OF FUNCTION
 (j) REC AMP
 (k) BIAS OSC
 (l) OUT PUT
 (o) OPTION
 (p) SELECTOR

— REC Signal Line
 — PLAY Signal Line

- 2SA952
- 2SA970
- 2SA992
- 2SA999
- 2A1015
- 2SC1815
- 2SC1845
- 2SC2240
- 2SC2300
- 2SC2320L
- 2SC2326
- 2SC2357
- 2SC2358
- 2SC2001
- 2SB526
- 2SB527
- 2SB528
- 2SD346
- 2SD357
- 2SD358
- 2SB631
- 2SD600 K
- 2SC2603
- 2SC2603
- 2SA1115
- 78M05H
- BA6109
- MSM4052RS
- M53203P
- M53207R
- MSM4001RS
- MSM4011RS
- MSM4066RS
- LA4170
- MSM4066RS
- µPD546C
- HA1203B
- MSM5366RS
- MSM4019RS
- M51207L
- M5218L
- RB152
- 2SK117.0 V
- µPA68H L, M
- 0526 8X
- 05212X
- 0525 1 X V
- 05213X Z
- 0525 6 V
- 05220V
- 10E 2
- 1S1588
- 1S2473D
- US 1035
- MV103

5-4. Control Section

* Design and specifications subject to change without notice for improvement.
 * La présentation et les spécifications sont susceptibles d'être modifiées sans préavis par suites d'améliorations éventuelles.
 * Änderungen, die dem technischen Fortschritt dienen, bleiben vorbehalten.

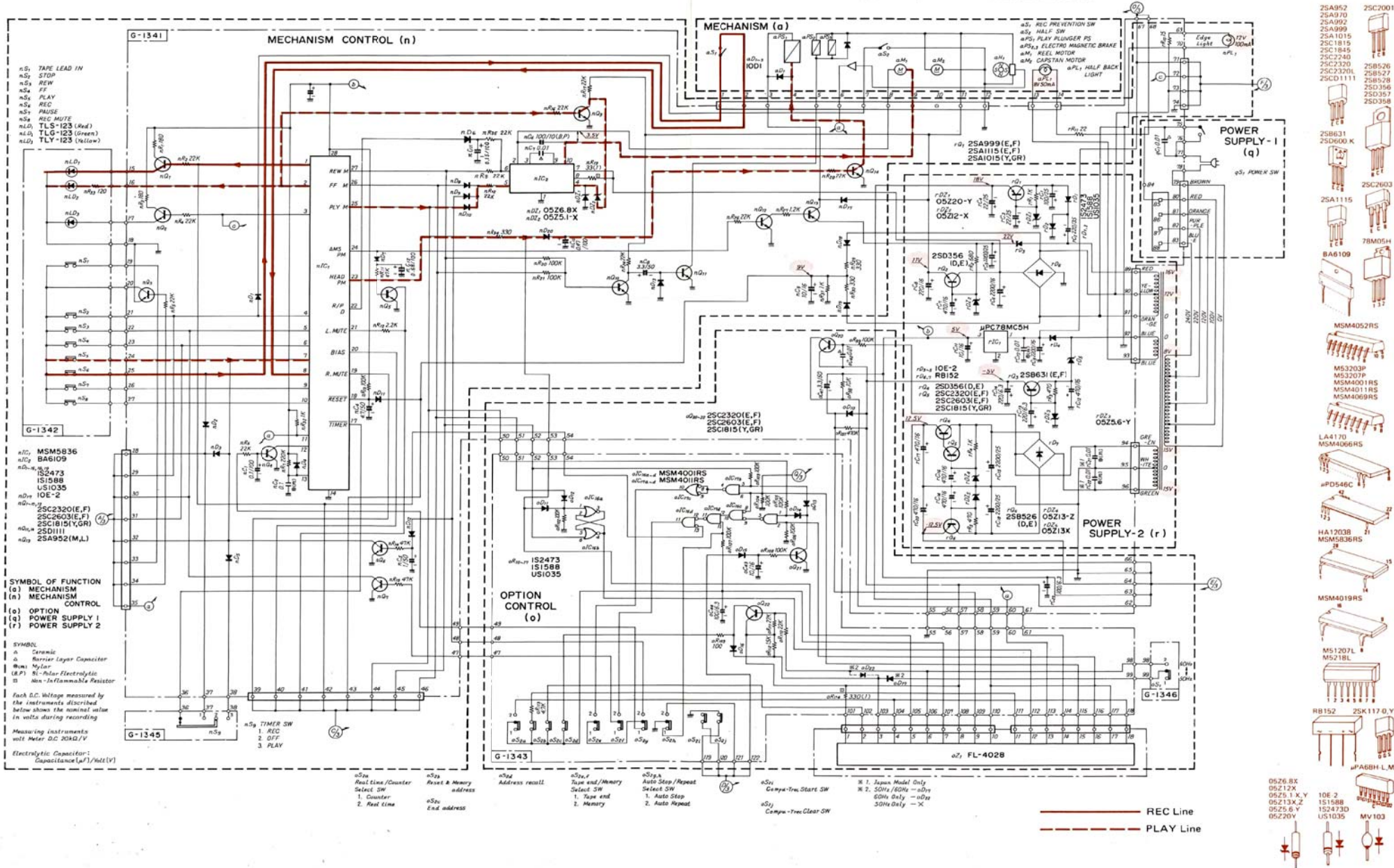

6. MAIN PARTS REPLACEMENT

A. Mechanism assembly

(See Exploded View on Page 17 & Top View on Page 19)

- 1) Remove the cassette lid.
- 2) Remove the bonnet and the front panel assembly.
- 3) Remove the bottom plate.
- 4) Extract two connectors (X) from the mechanism control board G-1341.
- 5) Remove the noise reduction board G-1353 and then extract one connector (Y) from the board and extract one connector (Z) from REC/PB AMP board G-1348. Lastely remove the harness.
- 6) Loosen out two upper and lower screws fixing the mechanism assembly.
- 7) Remove E-type washer (14) and spring (44) retaining cassette well lack Plate and pull out it.
- 8) Pull out the mechanical assembly for the rear panel side.

B. Cassette well assembly

- 1) Remove Mechanism Ass'y from set.
- 2) Remove the CS-type ring (46) retaining the damper spring (45).
- 3) Remove the CS-type ring (46) retaining the eject damper.
- 4) Remove three screws (42) fastening the cassette well mounting plate A.
- 5) Remove the cassette well assembly.

C. Capstan motor (Rotor) & Flywheel

- 1) Remove Mechanism Ass'y from set.
- 2) Loosen two screws (42) fastening play-plunger fixing plate.
- 3) Take out two circuit boards from Mechanism Ass'y.
- 4) Pull out poly-washer retaining capstan shaft.
- 5) Pull out rotor or flywheel.

D. Reel Motor assembly (17)

- 1) Perform "Section C. Capstan motor step 1) ~ 3)," first.
- 2) Cuts the harness of motor cords.
- 3) Loosen out five screws (3) (20) fastening reel motor fixing plate.
- 4) Take out reel motor with fixing plate.
- 5) Loosen out two screws (18) fastening reel motor.

E. Electromagnetic brake (19)

- 1) Remove mechanism Ass'y from set.
- 2) Loosen out two screws (51) fastening mechanism cover (50).
- 3) Loosen out one screw (3) fastening back tension adjusting plate A & poly-washer (24) retaining reel hub Ass'y (22) (23).

F. Idler (Fig. 7-2)

- 1) Remove the cassette lid.
- 2) Remove the mechanism cover assembly.
- 3) Remove the washer (17) retaining the idler.
- 4) Take out the idler.

G. Removement & Attachment of Lid Ass'y

Fig. 6-1

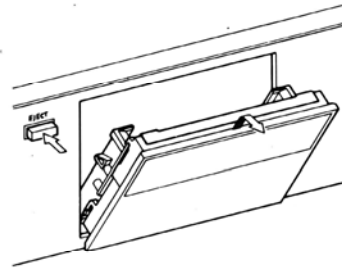

Depress the EJECT button to open the cassette Lid Ass'y, and pull the Lid Ass'y up and then toward you to remove it as shown in the figure.

Fig. 6-2

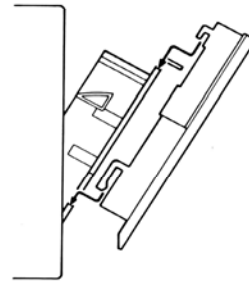

Re-attach the cover to the cassette Lid Ass'y by following the procedure for its removal in reverse.

7. EXPLODED VIEW & PARTS LIST

Parts List <Mechanism>

Parts No.	Stock No.	Description
1	65400300	Steel Ball, D = 2
2	09446800	Rec Lever
3	46396800	Screw, M2.5 x 5
4	47021500	Leaf SW,
5	47021600	Spacer,
6	09447000	Spring,
7	46198700	Rec & PB Head
8	09447300	Nut,
9	07736700	Screw, M2 x 13
10	07736300	Screw, M2 x 3
11	47021700	Plate, earth head
12	07736100	Earth Head
13	47021800	Screw, M2.5 x 4
14	00489200	E-type Washer, D = 3
15	08322600	E-type Washer, D = 2.5
16	09478800	Spring, half hold
17	09465100	Reel Motor Ass'y
17-1	07879300	Stopper Washer (See Fig. 7-2)
17-2	07879200	Idler
17-3	07879400	Poly-washer
18	07736400	Screw, M2.6 x 3
19	47022000	Magnet Brake
20	09461900	Screw, M2.3 x 4
21	09462000	Spring,
22	47022100	Reel Hub Ass'y, supply
23	09462200	Reel Hub Ass'y, take-up
24	07732600	Poly-Washer
25	09462400	Leaf SW,
26	09462700	Steel Ball, D = 3
27	47022200	DD Motor, capstan

Parts No.	Stock No.	Description
28	09462800	Nut, M9
29	09463700	Screw, M2 x 3.2
30	09463000	Pinch Roller Ass'y
31	07734700	Spring,
32	00489000	E-type Washer, D = 2
33	47022300	Spacer,
34	47022400	Spring,
35	00420600	Screw, M2 x 6
36	47022900	Back Tension Servo Ass'y
37	07661100	Adjusting Plate (B), back tension
38	00488900	E-type Washer, D = 1.5
39	07734000	Cushion
40	07719800	Plunger,
41	00449100	Screw, M3 x 6
42	47022500	Screw, M2.5 x 6
43	09463600	Magnetical Element
44	09464500	Spring,
45	09464700	Spring,
46	51830000	CS-type Washer
47	09464600	Damper Ass'y
48	47022600	Screw, M2.5 x 25
49	00470200	Toothed Lock Washer
50	47022700	Mechanism Cover Ass'y (red)
51	09465000	Screw, M2.5 x 5
52	09465200	Cassette Well Ass'y
52-1	09465600	Cassette Half Spring
52-2	09464400	Screw, M2.6 x 8
53	09461600	Spacer, Rec & PB head
54	47021900	Brake case

7-1. Cassette Well Ass'y

Fig. 7-1

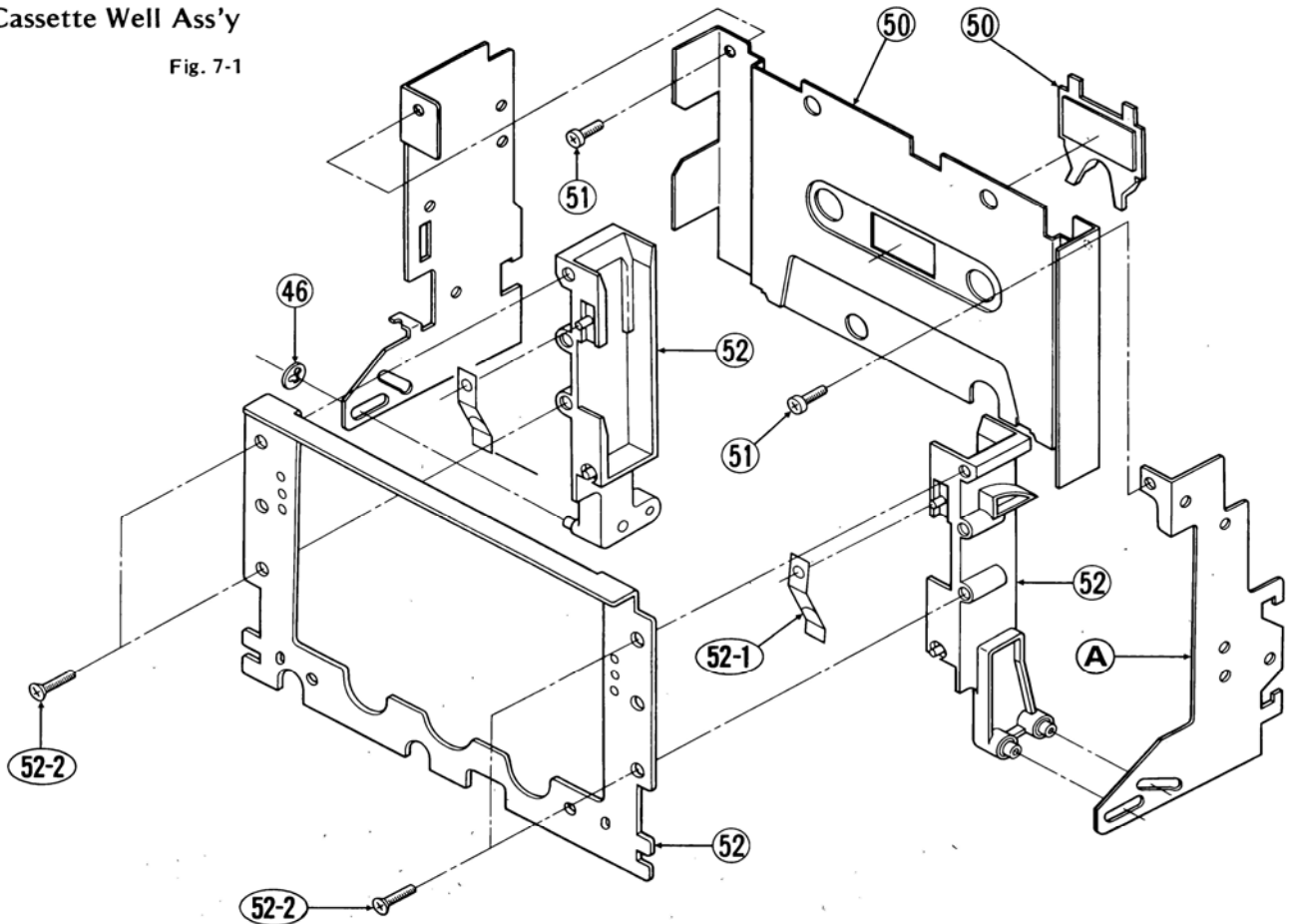

7-2. Mechanism Ass'y

Fig. 7-2

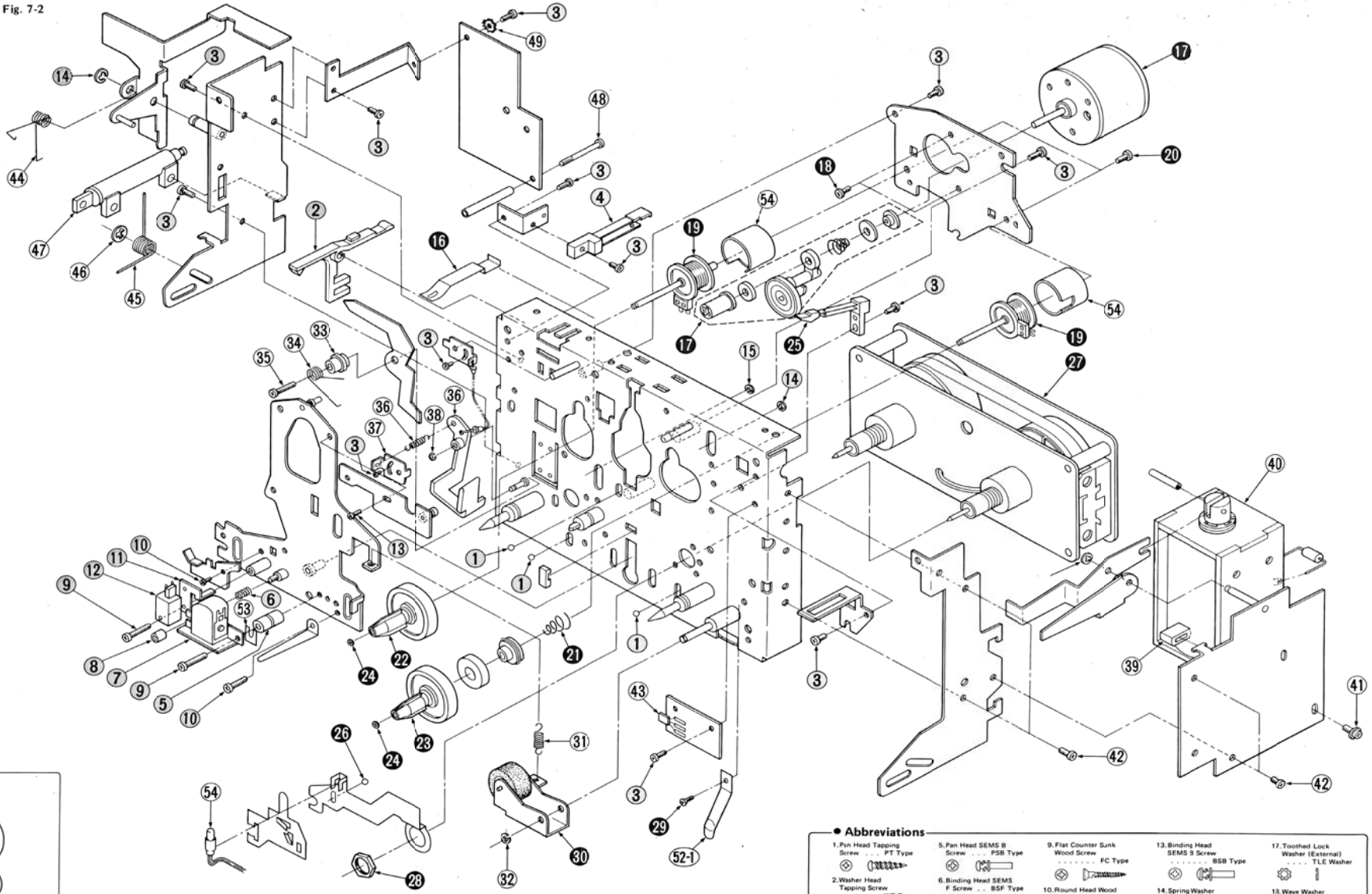

- ① ~ ⑮
- ⑯ ~ ⑳
- ㉑ ~ ⑵②

7-3. Idler Ass'y

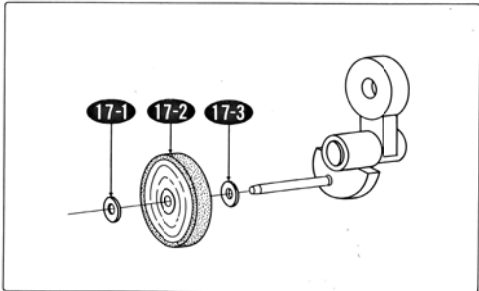

• Abbreviations

1. Pin Head Tapping Screw ... PT Type	5. Pan Head SEMS B Screw ... PSB Type	9. Flat Counter Sunk Wood Screw ... FC Type	13. Binding Head SEMS S Screw ... BSB Type	17. Toothed Lock Washer (External) ... TLE Washer
2. Washer Head Tapping Screw ... WT Type	6. Binding Head SEMS F Screw ... BSF Type	10. Round Head Wood Screw ... RH Type	14. Spring Washer ... S Type	18. Wave Washer
3. Pan Head Screw ... P Type	7. Binding Head Screw ... B Type	11. Hex. Socket Setscrew ... SC Type	15. Plain Washer ... P Type	19. Hexagon Nut H Type Nut
4. Pan Head SEMS A Screw ... PSA Type	8. Flat Counter Sunk Head Screw ... F Type	12. Slot Type Setscrew ... SS Type	16. Retaining Ring (E Washer) ... E Type	

8. OTHER PARTS

8-1. Front View

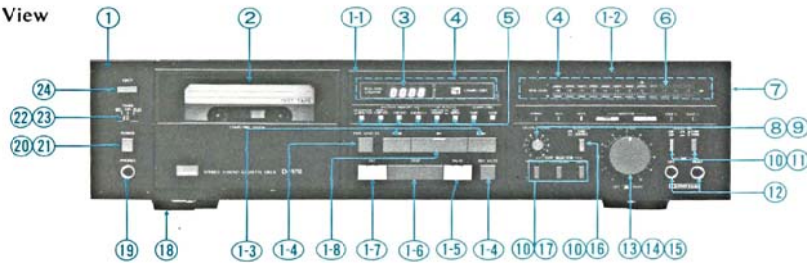

8-2. Top View

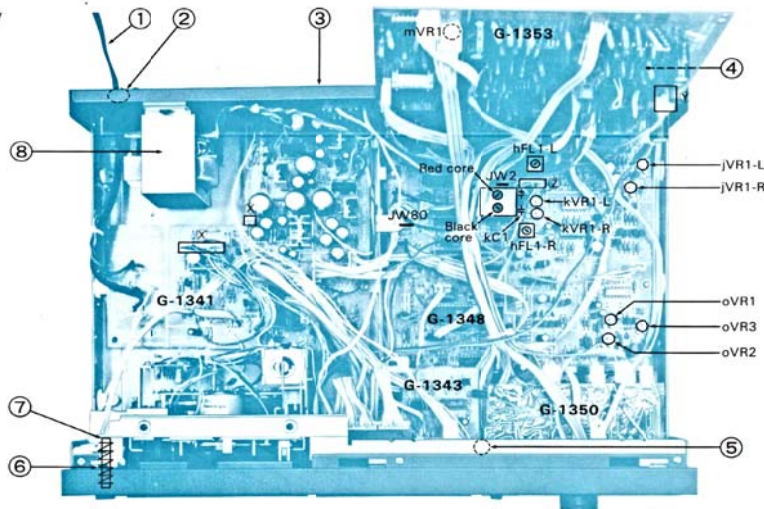

Parts List <Front View>

Parts No.	Stock No.	Description
1	09445910	Front Panel Ass'y
1-1	09427100	Counter Glass
1-2	09426500	Meter Glass
1-3	09437800	Push Button, ►►, ◀◀
1-4	09428300	Push Button, REC MUTE, TAPE LEAD IN
1-5	09455000	Push Button, PAUSE
1-6	09437600	Push Button, STOP
1-7	09448900	Push Button, REC
1-8	09448700	Push Button, ►
2	09449700	Lid Ass'y
3	46164500	Fluorescent Display Tube, counter
4	09447900	Meter Frame Ass'y
5	09425800	Push Knob, COUNTER, DUAL MEMORY, AUTO COMPU-TREC Peak Level Meter (L.E.D. LT1051)
6	46176800	Bonnet
7	09425300	Knob, OUTPUT VR
8	07680600	VR, OUTPUT
9	46208800	Push Knob, DOLBY, TAPE SELECTOR, MONITOR
10	09443700	Push SW., DOLBY
11	46177900	Jack, MIC
12	46212000	Knob, REC LEVEL LEFT
13	09419400	Knob, REC LEVEL RIGHT
14	09419500	

Parts No.	Stock No.	Description
15	46177000	VR, REC LEVEL
16	46221300	Push SW., TAPE MONITOR
17	46178000	Push SW., TAPE SELECTOR
18	07822700	Leg
19	46265700	Jack, PHONES
20	07809800	Push Knob, POWER
21	46087300	Push SW., POWER
22	09444600	Slide Knob, TIMER
23	46177800	Slide SW., TIMER
24	07829400	Push Knob, EJECT

Parts List <Top View>

Parts No.	Stock No.	Description
1	38004700	Power Supply Cord
2	39106000	Strain Relief
3	11102800	Slide SW., REAL TIME SET
4	07249100	4P INPUT/OUTPUT Terminal
5	46220700	Pilot Lamp, 8V 50mA
6	09419800	Compression Spring
7	09419100	EJECT Bar
8	15007301	Power Transformer

9. PACKING LIST

Parts No.	Stock No.	Description
1	91167610	Vinyl Bag
2	07811900	Styrofoam Packing
3	09459500	Carton Case

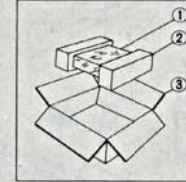

10. ACCESSORY LIST

Stock No.	Description
46143400	Operating Instruction
38103300	Pin Plug Cord

SANSUI ELECTRIC CO., LTD.:

14-1, Izumi 2-chome, Suginami-ku, Tokyo 168 Japan
PHONE: (03) 324-8891/TELEX: 232-2076 (International Division)

SANSUI ELECTRONICS CORPORATION:

1250 Valley Brook Ave. Lyndhurst, N.J. 07071 U.S.A.
333 West Alondra Blvd. Gardena, California 90247 U.S.A.

SANSUI ELECTRONICS (U.K.) LTD.:

3036 Koapaka St. Honolulu, Hawaii 96819 U.S.A.

SANSUI ELECTRONICS G.M.B.H.:

Unit 10A, Lyon Industrial Estate, Rockware Avenue, Greenford, Middx UB6, OAA, England
Paul Ehrlich Strasse 8, 6074 Rödermark 2, West Germany